

NB ! This installation diagram must only be used as a guideline for the installation. Equipment delivered with the car varies considerably from model to model and from market to market. Before starting the installation, be sure to check carefully the original diagram from the car manufacturer. DEFA AS is not liable to compensate for possible damages that may occur due to faulty or insufficient installation manuals.

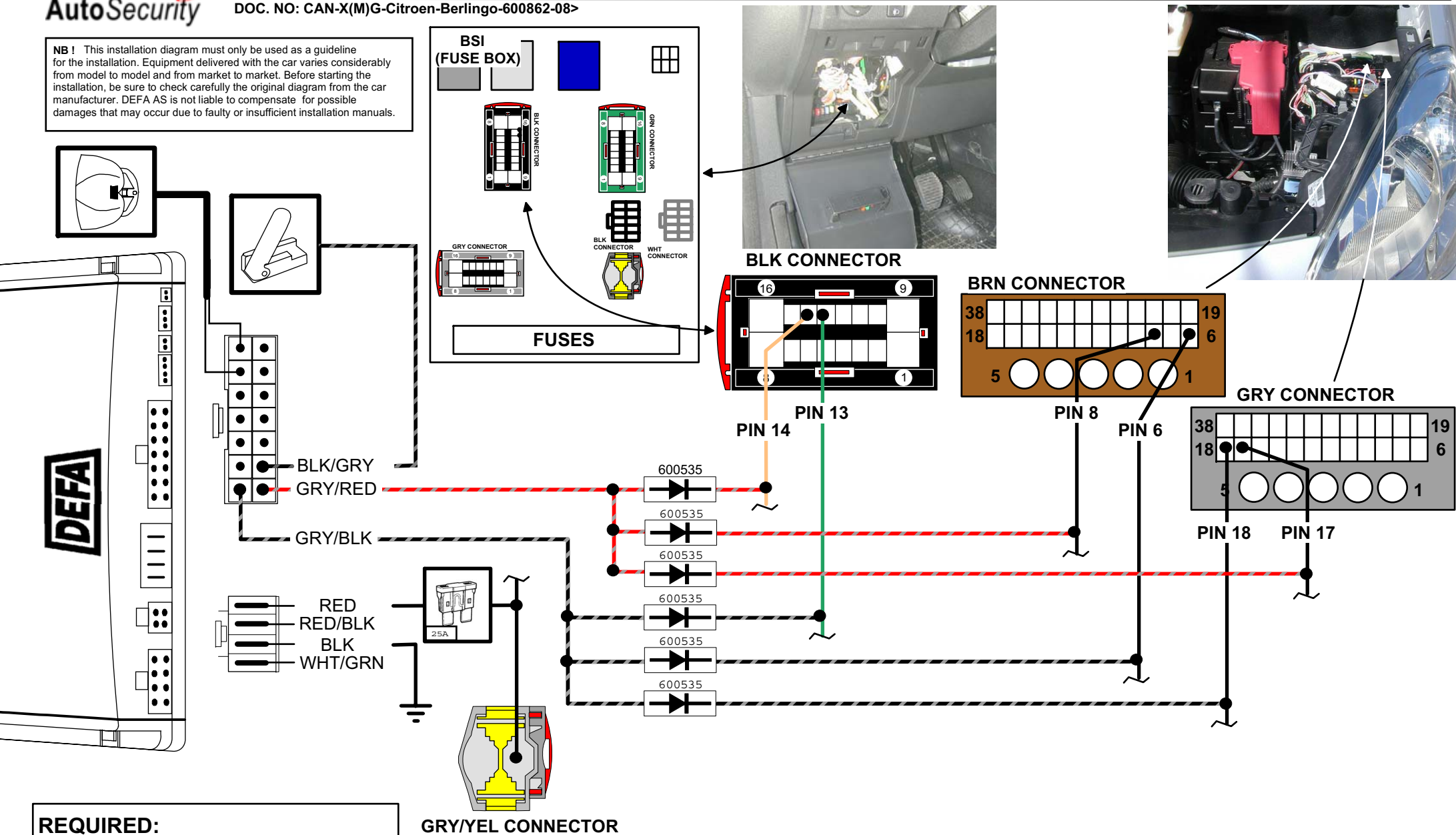

REQUIRED:

- Alarm: CAN Alarm PSA
- Minimum Central Unit rev: J
- Minimum Required SoftWare: 02
- 6 Diodes (2 x 600535)

Date : 2008. 07. 02
Rev : A
Page: 1 of 5

ALTERNATIVE CAN CONNECTION POINTS:

CAN H: PIN 24. WHT 40 PIN CONNECTOR.
CAN L: PIN 26. WHT 40 PIN CONNECTOR.

CAN H: PIN 4. BLK 6 PIN CONNECTOR.
CAN L: PIN 6. BLK 6 PIN CONNECTOR.

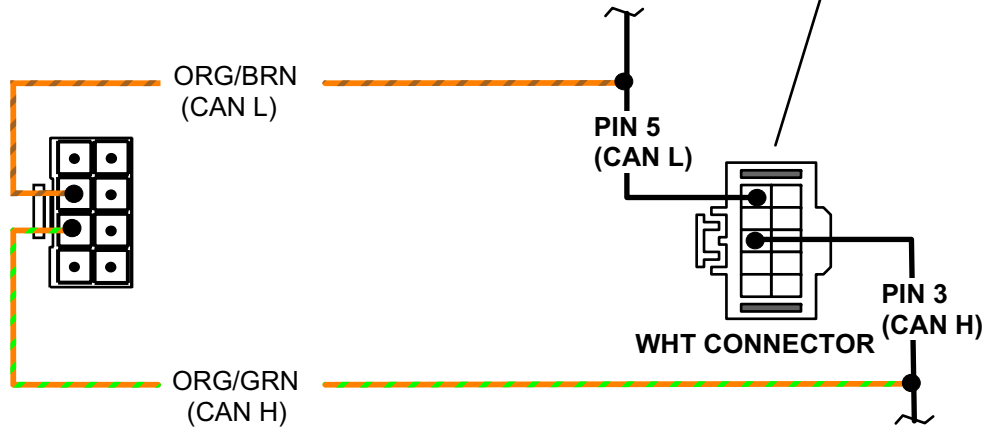
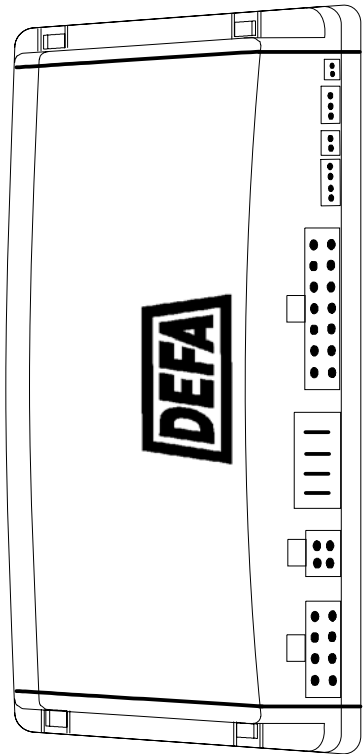
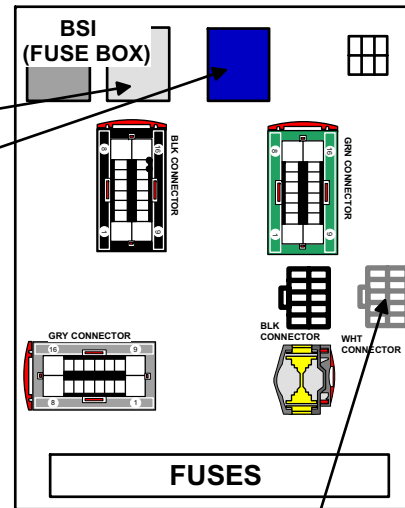

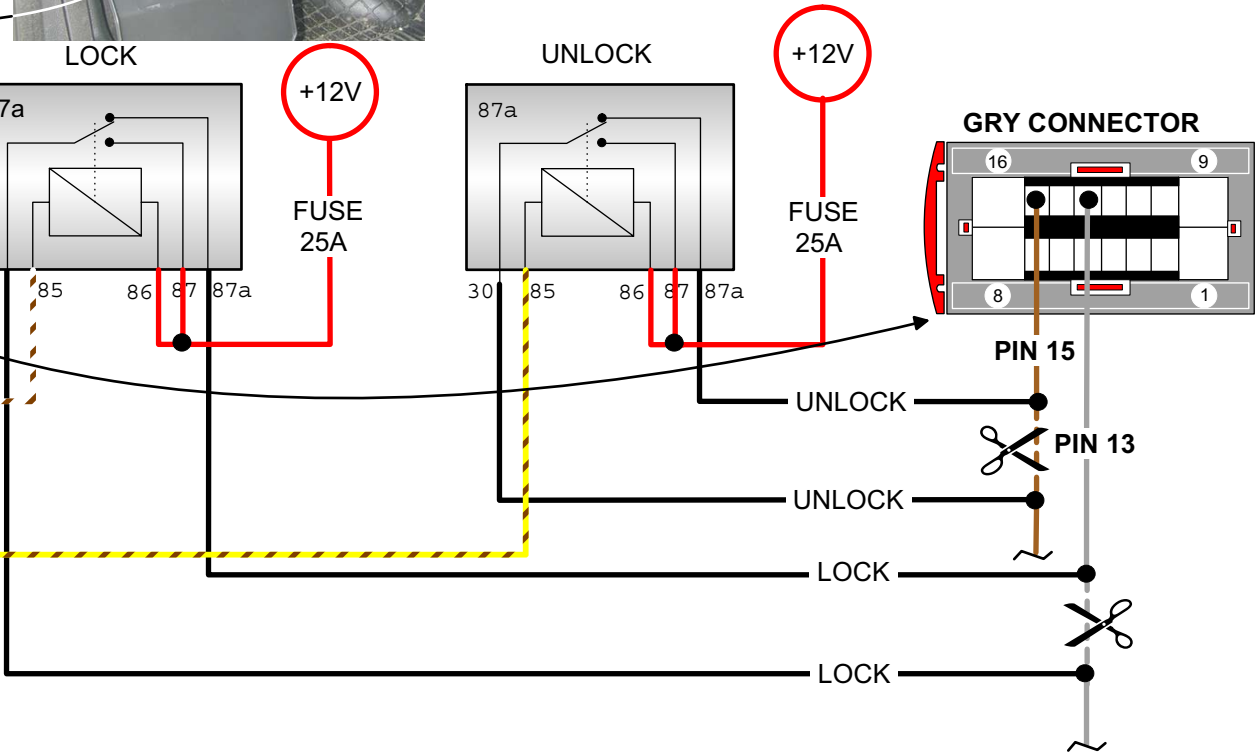
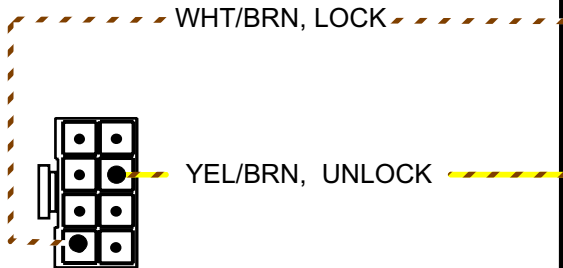
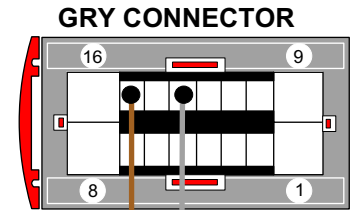
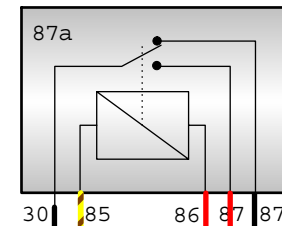
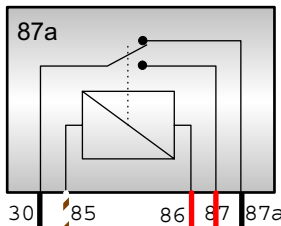
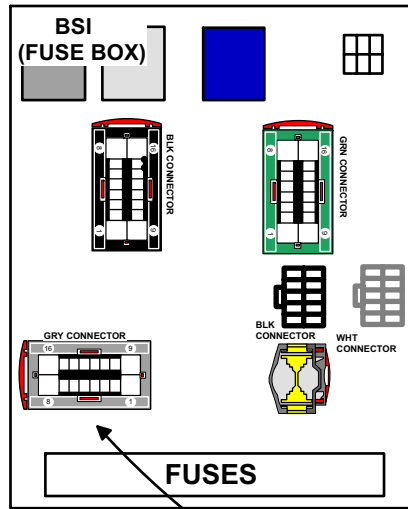
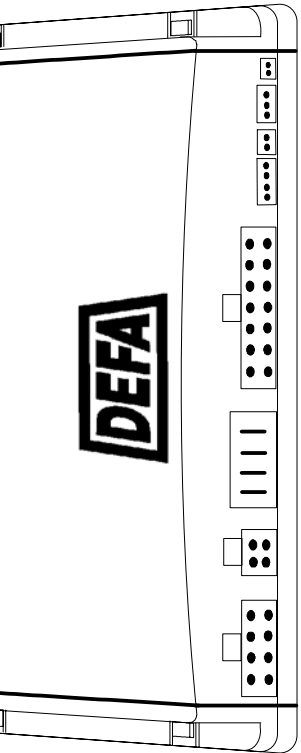

Programming:
 - PROG NR: 8.2.
 - PROG NR: 15.1.

Date : 2008. 07. 02
 Rev : A
 Page: 3 of 5

Attention!!

1. Install the DEFA alarm.
2. Connect the diagnostic tool, and choose installation of standard alarm.



